

CITIZEN®

Setting Instructions for Movement Caliber D200, D202, D206, D208

CONTENTS (click on a topic)

1. FEATURES OF THIS WATCH
 - a. Various warning functions
 - i. Ascending Speed Warning
 - ii. Depth Indication Warning
 - iii. Battery Lifetime Forecast
 - iv. Water Sensor Check Warning
 - v. Abnormal Pressure Sensing Error Warning
2. SPECIFICATIONS
3. NAME OF EACH PART
 - a. Symbol marks indicated by the dot indicator and their meanings
4. HOW TO CHANGE THE MODE [FUNCTION]
5. TIME AND CALENDAR MODE
6. HOW TO SET THE TIME AND CALENDAR
7. ALARM MODE
8. DIVING MODE
 - a. Meanings of "valid diving" and "invalid diving" used for this watch
9. SURFACE MODE
10. LOG MODE
11. TRANSFER MODE
12. ALL-RESET PROCEDURE
13. BATTERY LIFETIME FORECAST AND BATTERY
14. CARE OF YOUR WATCH





1. FEATURES OF THIS WATCH

This product is a digital diver's watch that has an electronic depth meter.

1. Since a water sensor is installed, this watch start measuring the depth as soon as the user starts diving.
2. This watch measures the atmospheric temperature, as well as the water temperature while the user is diving.
3. Various log data are record while the user is diving.
4. After finishing diving, the data recorded in this watch can be transferred to a personal computer, by using the communication unit, and then the data can be checked with the personal computer.
 - Applicable personal computer: IBM PC/AT or compatible, with keyboard and monitor.
5. This watch measures time automatically after the valid diving is finished (up to 24 hours). This function is used to check the rest time on the water surface (Surface function).
6. This watch has water-resistant performance and various warning functions necessary for safe diving.

Various warning functions

This watch has five warning functions to avoid dangers and troubles that may occur during diving.

These warning functions indicate only reference values for safe diving. The degree of each danger depends on the experience, physical condition, or diving condition of the user. This watch does not assure safety even if it does not turn on any alarm.

1. Ascending speed warning

Warning system

- "SLOW" flashes in the dot indicator window.
 - Beeping sound comes out for 5 sec.

Operating condition

- [Depth indication in diving mode]
 - The ascending speed exceeds 0.3 m/sec for 5 sec continuously.

Countermeasures

- Lower the ascending speed.

2. Depth indication error warning

Warning system

- "ERR" flashes in the dot indicator window.
 - The accuracy of the depth indication is not assured while the error is indicated.

Operating condition

- [Depth indication in diving mode]
 - The surfacing or diving speed exceeds 4 m/sec.

Countermeasures

- After diving mode is finished, if the watch can be returned to the normal mode, there is not a problem in it.





3. Battery lifetime forecast

Warning system

"BAT." flashes in the dot indicator window.

- o The watch cannot be set to diving mode.
- o The alarm does not sound. • The lamp does not light up.

Operating condition

- Depth indication in diving mode or normal model
 - o The battery reaches almost the end of its life

Countermeasures

- If the battery is replaced, all the diving data are deleted. If any necessary diving data is stored in the watch, take the record of the log data or transfer it to a personal computer.

4. Water sensor check warning

Warning system

- "CHEK" is indicated in the dot indicator window.
 - o The watch cannot be set to the diving mode.

Operating condition

- [Ready state in diving mode or normal mode]
 - o The water sensor has been turned on for 1 hour on land or in water shallower than 1 m.

Countermeasures

- If the water sensor is wet: Wipe it with dry cloths.
- If the water sensor is stained: Wash in fresh water with a soft cloth.

5. Abnormal pressure sensing error warning

Warning system

- "ERR" is indicated in the dot indicator window.
- The watch cannot be set to the diving mode.

Operating condition

- [Normal mode)
- An abnormal atmospheric pressure is detected.

Countermeasures

- Do not use this watch at a place higher than about 4,000 m.





2. SPECIFICATIONS (subject to change without prior notice)

Type	Digital diver's watch with depth meter, thermometer, and water sensor
Time <u>accuracy</u> (At normal temperature)	±20 seconds/month
Depth meter accuracy	±(3% of indicated value + 30cm (1ft)) max. Only when used at a fixed temperature range *Using temperature range: 10'C-40'C(50'F-104'F) Depth meter accuracy is affected by change of temperature however.
Indication method	Digital indication
Operating temperature range of time system	-10-C - 60-C (14-F - 140-F)
Time	Hour, minute, and second
Calendar	Month, date, and day
Temperature indication (including the lowest water temperature indicated in the log mode)	-5'C - 14"C (Unit: 1 IC) ±3'C/15'C - 400C (Unit: 1 OC) ±20C 230F - 570F (Unit: 1 OF) ±6"F/59OF - 104"F (Unit: 1 IF) ±4F
Present depth indication	1.0 m - 80.0 m (Unit: 10 cm) (0 m is indicated when shallower than 1.0 m], 4 ft - 260 ft (Unit: 1 ft)
Maximum depth indication	1.0 m - 80.0 m (4 ft - 260ft)
Average depth	1.0 m - 80.0 m (4 ft - 260 ft)
Month and date of diving	Month and date
Start time of diving	Hour and minute
Finish time of diving	Hour and minute
Diving time	0 min - 199 min
Number of diving times	1 - 9
Functions	<ul style="list-style-type: none">• Time and calendar mode• Surface mode• Alarm mode• Log mode• Diving mode• Transfer mode• Depth indication error warning function• Battery lifetime forecast function• Water sensor check warning function• Ascending speed warning function• Abnormal pressure sensing error warning function
Additional functions	<ul style="list-style-type: none">• Water resistance for 200m diving• Water sensor (Used as transfer terminal)
Battery	Lithium battery (CR2025)
Battery Life	Average of 2 years after new battery is installed. (Varies with use and number of dives)
Additional Notes	Movement Calibers D200 and D202 are metric (meters) measurement versions Movement Calibers D206 and D208 are standard (feet) measurement versions





3. Name of Each Part

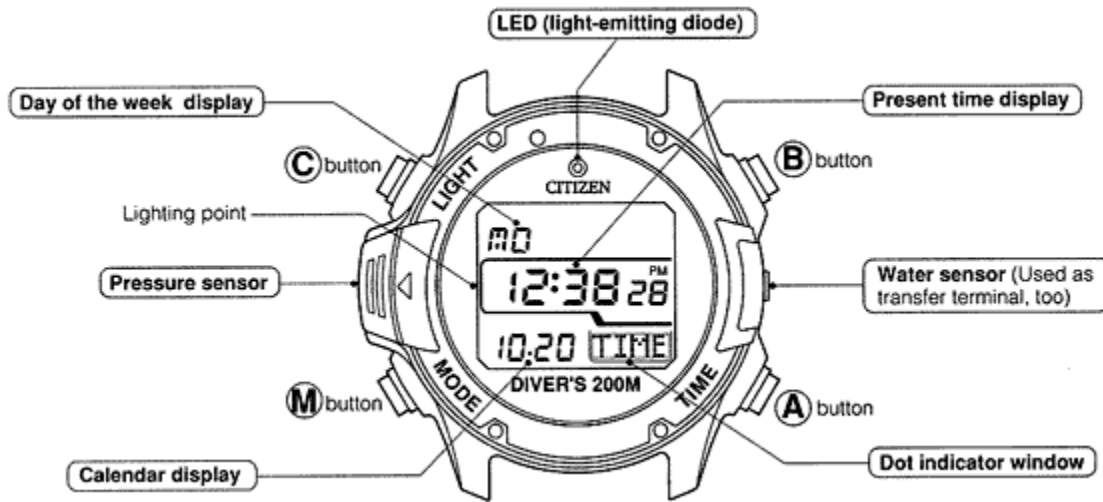

[Symbol marks indicated by the dot indicator and their meanings]

	Mode indication
	Time and calendar mode Alarm mode
	Temperature is being measured
	Log mode (When profile data is not recorded)
	Log mode (When profile data is recorded)
	Surface mode (Surface interval time) (Time after valid diving is finished)
	Transfer mode
	Data is being transferred
	Diving Mode (Diver Swims)
	Alternative indication
	Each Mode Indication: Ready for Diving
	Ready for diving Warning indication
	Surfacing speed warning
	Various checks
	Battery lifetime forecast
	Various errors

For the explanation of the "Profile data", refer to section "10. Log mode".





4. HOW TO CHANGE THE MODE (FUNCTION)

The mode of this watch is changed when the (M) (bottom left) button is pushed or the water sensor is wet with water.

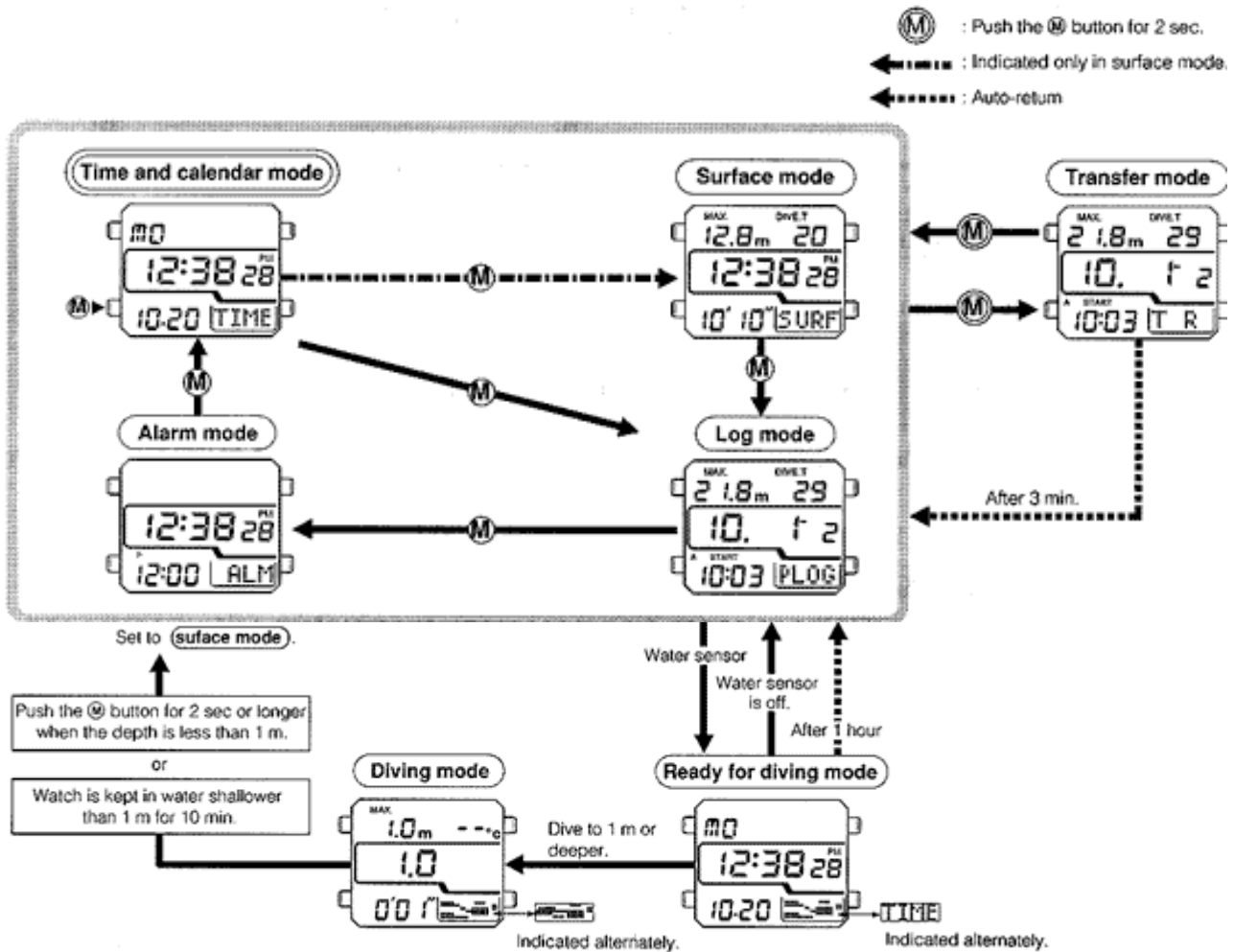

5. TIME AND CALENDAR MODE

In this mode, the present time and calendar are indicated.

- In the normal time mode, the LED (light-emitting diode) at the 12 o'clock position flashes every hour on the hour for 3 seconds. (Example: 07: 00: 00, 07: 00: 01, 07: 00: 02)
- If the (A)(lower right) button is pushed in the time and calendar mode, the watch measures the temperature (First temperature is indicated). In this mode, the temperature is measured at the interval of 10 seconds for 3 minutes. "-- °C" is indicated, however, until the first measurement is finished.

After 3 minutes, the watch automatically starts measuring the second temperature at the interval of 30 minutes. The temperature measurement range is -5°C - 40°C. The watch cannot measure the temperature correctly, however, if it is put on the wrist. When measuring the correct temperature, take it off.

- In the time and calendar mode, if the @ button is pushed, the flashing operation of the LED can be checked. (For 5 seconds)
- If the (C)(upper left) button is pushed and held, the lamp is kept turned on for 10 seconds. The lamp goes off about 1.5 seconds after the (C)(upper left) button is released.



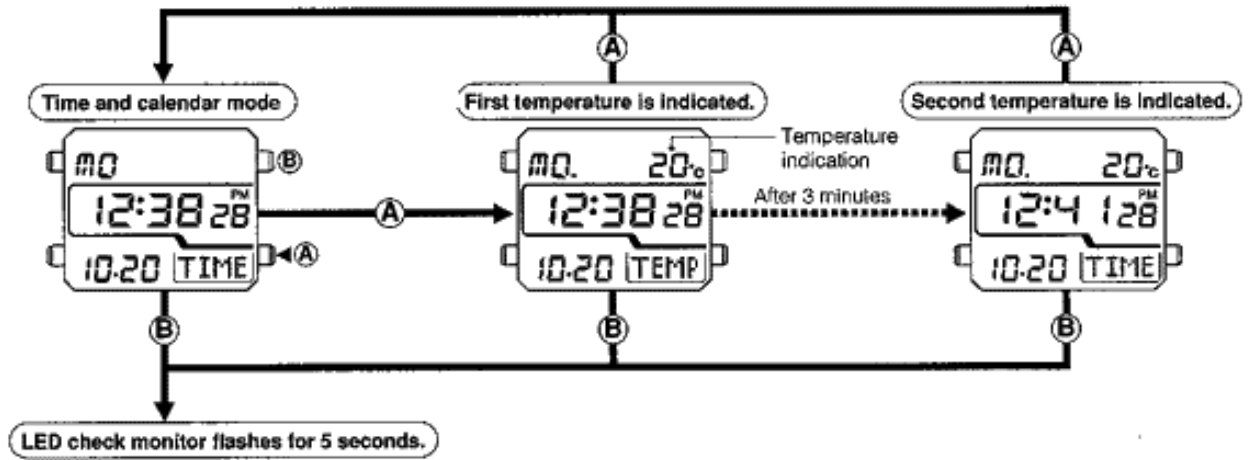

6. HOW TO SET THE TIME AND CALENDAR

- o When correcting the time, push the (B) (upper right) button for 2 seconds to flash the "second" in the time and calendar mode.
- o Push the (B) (upper right) button further to select a part to be corrected.
- o Correct the flashing part by pushing the (A) (lower right) button.

If the year correctly set to the calendar, it is not necessary to correct the calendar at the end of each month (including the leap years).

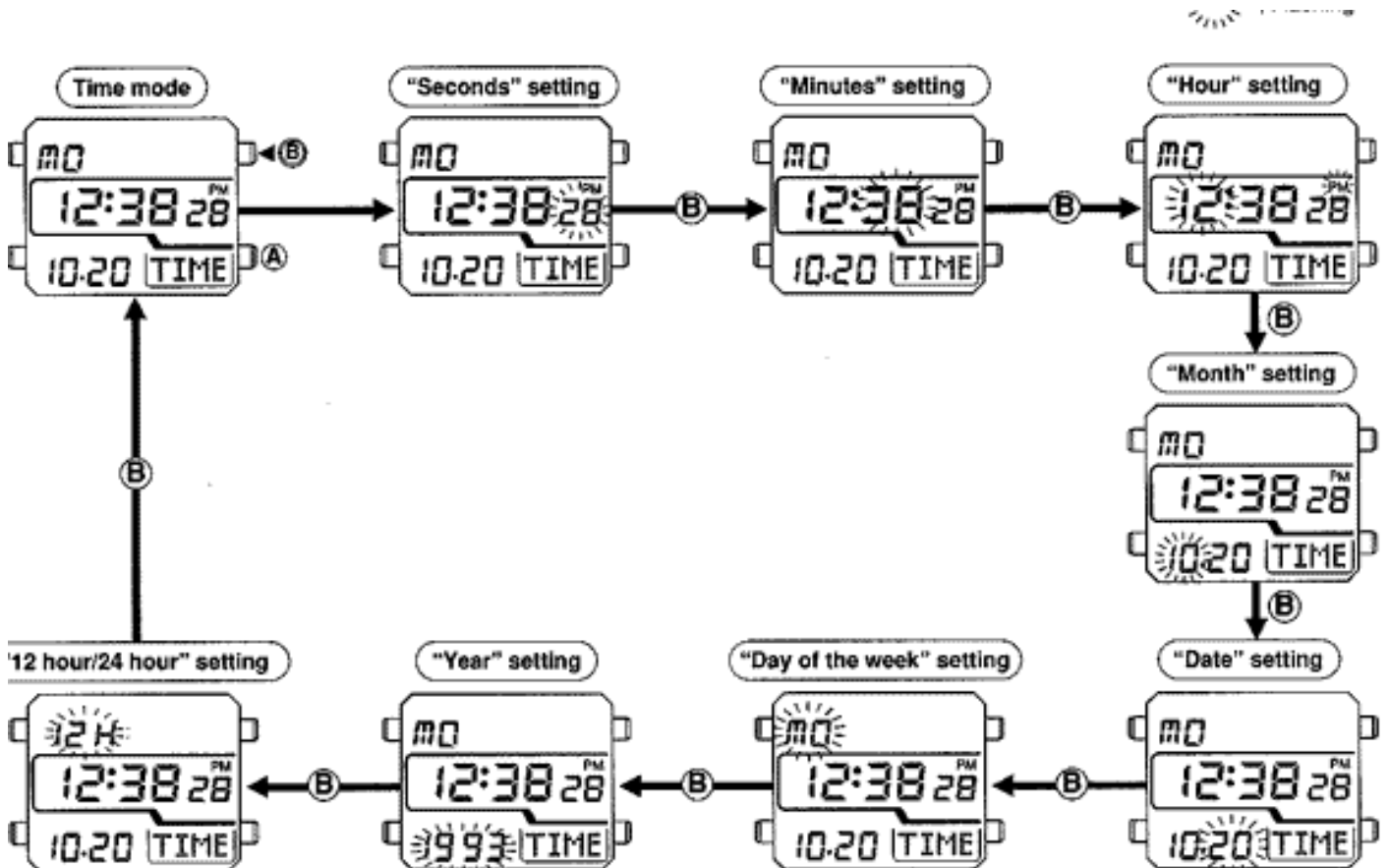



7. ALARM MODE

Once the alarm time is set, this watch sounds the alarm at the same time every day like an alarm clock. This sound continues for 15 seconds. Set the alarm according to the following procedure.

1. Push and hold the **(B) (upper right)** button for 2 seconds, and the alarm "hour" can be set (It flashes).
2. Set the alarm "hour" with the **(A) (lower right)** button.
3. Push the **(B) (upper right)** button once again, and the alarm "minute" can be set (it flashes).
4. Set the alarm "minute" with the **(A) (lower right)** button.
5. If the @ button or the 9 button is pushed, the alarm time is set.
 - • Turn on and off the alarm with the **(A) (lower right)** button. If the **(A) (lower right)** button is pushed and held, the alarm sound can be checked.
 - • If the **(C) (upper left)** button is pushed and held, the lamp is kept turned on for 10 seconds. The lamp goes off about 1.5 seconds after the **(C) (upper left)** button is released.

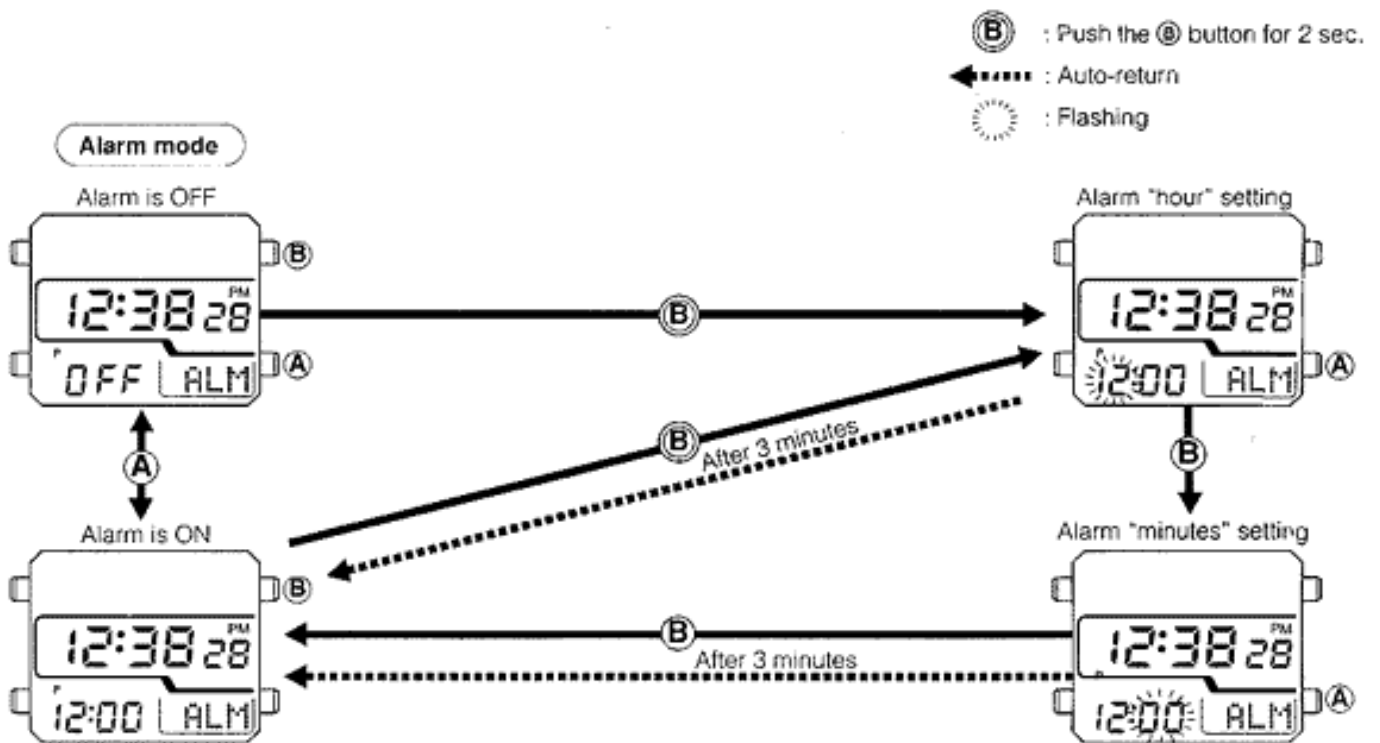

8. DIVING MODE

In the diving mode, this watch measures water depth.

- If the water sensor is turned on in the time and calendar mode, surface mode, log mode, or alarm mode, the watch is ready for the diving mode.
 - If the watch is kept in the ready state for the diving mode for 1 hour after the water sensor is turned on, the dot indicator indicates "CHEK". In this case, wipe water off the water sensor and confirm that "CHEK" goes off.
- In the ready state for the diving mode, if water pressure at 1 m or deeper is applied to the sensor, the watch starts to indicate the depth (Diving mode).



If the watch is set to the "diving mode",

- 1) A swimming diver is displayed in the dot indicator to indicate that the watch is in the diving mode.
- 2) The LED flashes every 4 seconds to indicate that the watch is in the diving mode.
- 3) The depth is measured and indicated at the interval of 1 second. The measurement range of the depth is 1.0 m(4ft) - 80.0m(260ft). If the depth exceeds 80.0 m(260ft), "- . -m" ("- . -f") is indicated, and if the former is less than 1.0 m(4ft), "0.0 m(0.0ft)" is indicated to shown the diver that the watch is out of the measurement range.
- 4) The diving time is measured and indicated by the unit of 1 second for the first 29 minutes and 59 seconds, then by the unit of 1 minute up to 199 minutes. After 199 minutes, the watch starts measurement again from 0 seconds.
- 5) The watch starts indicating the water temperature 1 minute after the diving is started, then it continue the measurement and indication at the interval of 1 minute. The measurement range of the water temperature is -5°C - 40°C(27-57F). The watch indicates "- . IC" out of this range.
- 6) While the **(A) (lower right)** button is pushed, the watch indicates the present time. If the **(A) (lower right)** button is released, the watch starts indicating the depth again about 1.5 seconds after. While the **(C) (Upper Left)** button is pushed, the lamp lights up for 10 seconds maximum. The lamp goes off about 1.5 seconds after the **(C) (Upper Left)** button is released.

Example: Watch gets ready for diving mode from the "time and calendar mode".

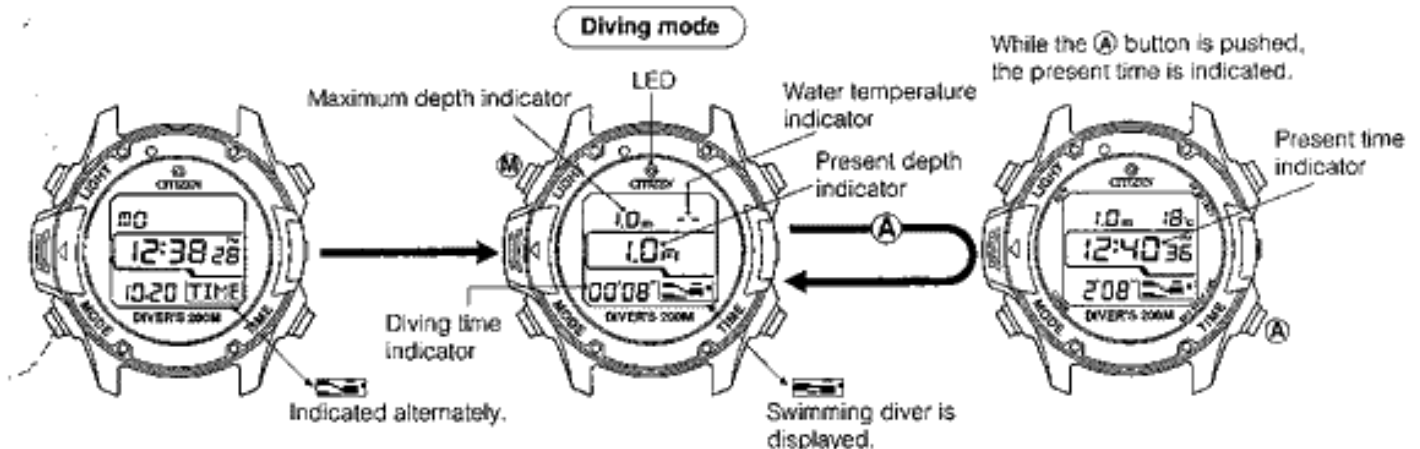

Resetting the diving mode

- 1) If the watch is kept in water shallower than 1m(4ft) (indicated depth: 0m(0ft)) for about 10 minutes, the diving mode is reset automatically. After the diving mode is reset, the watch is set as follows, depending on the diving condition.
 - a. In case of valid diving:
The watch is set to the surface mode (for measurement of rest time above water).
 - b. In case of invalid diving:
The watch is set to the time and calendar mode or the surface mode which has been continued from the previous time.
- 2) If the **(M) (lower left)** button is pushed and held for 2 seconds, the diving mode is reset. After the diving mode is reset, the watch is set as explained in section 1 above. If the water sensor is wet, however, the dot indicator indicates the diver and mode alternately.

[Meanings of "valid dives" and "invalid dives" used for this watch]

Valid diving: Dives including a dive deeper than 1m(4ft) continued for at least 3 minutes.

Example of one dive: (Valid dives)

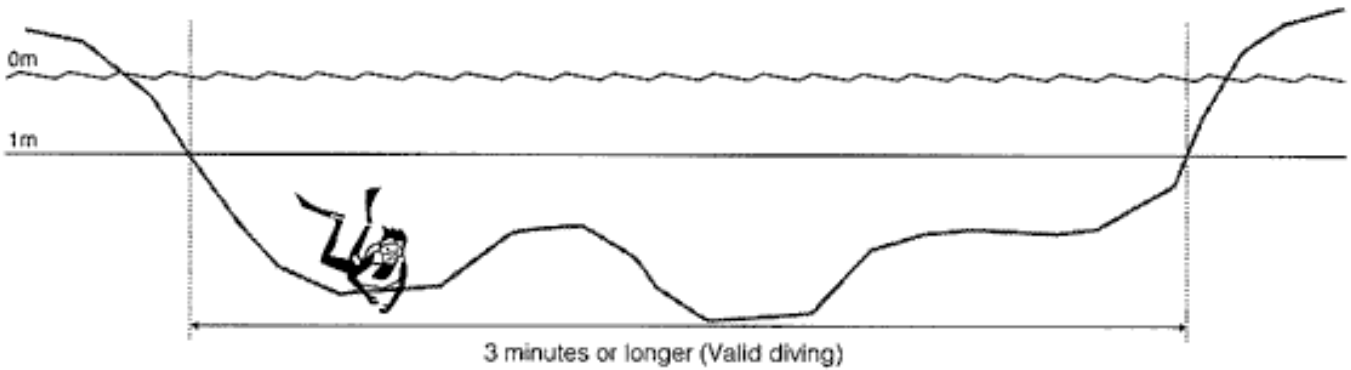

Invalid dive: Dives that does not include dives deeper than 1m(4ft) continued for at least 3 minutes.

Example of one dive: (invalid diving) 0m(0ft)

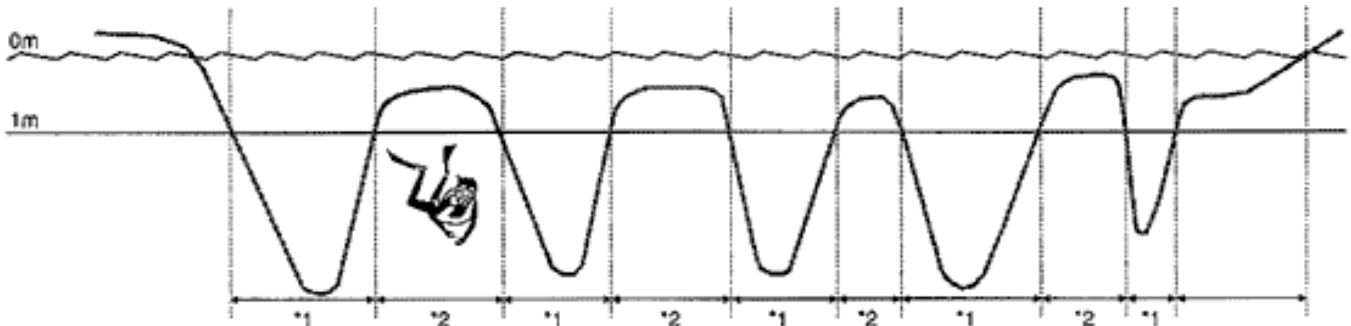

- *1: Shorter than 3 minutes
- *2: Shorter than 10 minutes

One dive: One dive measured by this watch is the period from the point when the diver dives deeper than 1m(4ft) to the point when diver returns to a point shallower than 1 m next time.

If the diver dives again deeper than 1 m before staying at a point shallower than 1m(4ft) for 10 minutes, the dive is assumed to be continuous, that is, the watch counts this continuous diving as one dive.

Example of one dive: (Valid dive)

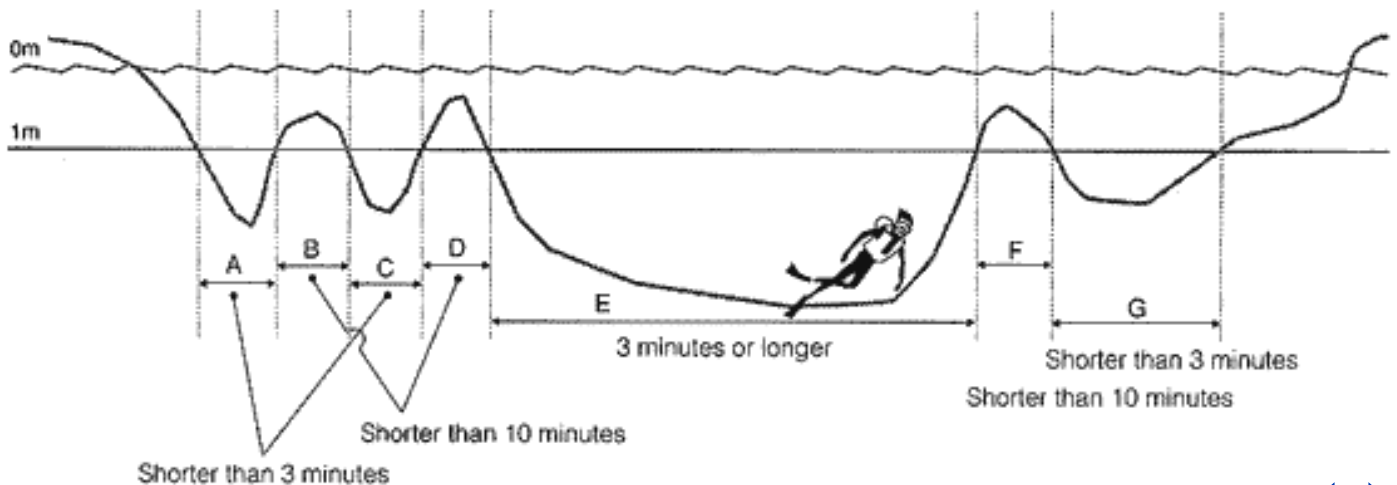

Examples of a valid dives and an invalid dives indicated by the watch

Indication of a valid dive in the log mode.

A number is indicated in the diving No. section to indicate how many dives (valid) have been performed

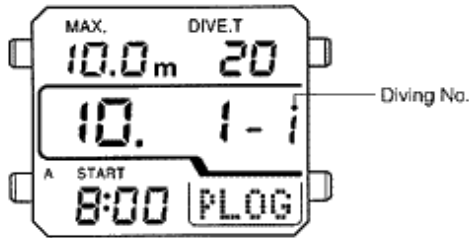

Indication of an invalid dive in the log mode

"- -" is indicated in the diving No. Section

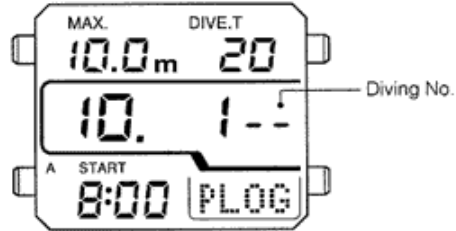

- ❖ If invalid dives are performed many times repeatedly (Skin diving, etc.), they are indicated as one invalid dive, and all of the maximum depth, average depth, lowest water temperature, dive start time, and diving finish time are checked through that dive.
- ❖ If the diver takes a rest longer than 10 minutes between invalid dives, the watch counts two invalid dives.

9. SURFACE MODE

In this mode, the time after the latest valid diving is finished*' (the rest time on the water) is automatically measured. This function is used to measure the rest time roughly after each diving is finished.

*1: See "Meanings of valid dives and invalid dives used for this watch".

In this mode, the watch operates as follows.

- The watch automatically starts the measurement of the time after a valid diving is finished (up to 24 hours). -4 The watch is set to the "SURF" mode.
- If the watch has measured 24 hours, it automatically stops measuring and indicating the time in "SURF" mode. This mode is not indicated until the next valid diving is finished.
- Each time a valid diving is finished, the time is measured from "0 second".
- **The measurement cannot be started or finished with the push buttons in any case.**

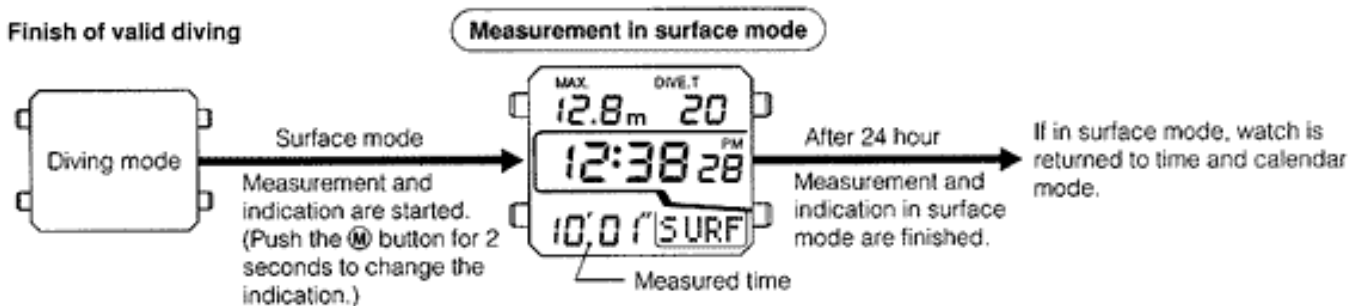

[Change of mode indication]

After valid dive is finished
 - Measurement and indication in surface mode are started

After measurement and indication in surface mode are finished
 - Measurement and indication in surface mode are finished

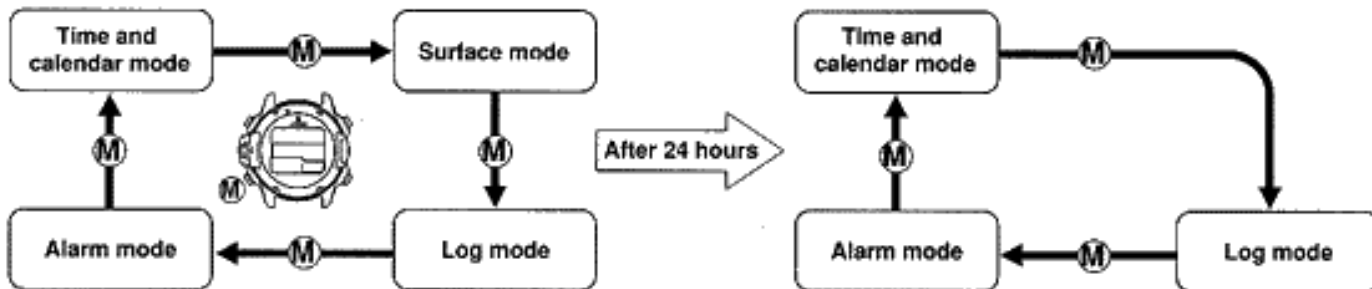

10. LOG MODE

In this mode, the data automatically recorded in the dive mode can be checked.
 Log data: (Can be checked in the log mode of the watch.)

- Eight data of the maximum depth, diving time, month and date of diving, diving No., diving start time, average depth, lowest water temperature, and diving finish time.
- The log data of up to 30 dives can be recorded.
 - (If the 31st dive is performed, the oldest data is deleted, and the data of the latest 30 dives are recorded.)
 - Profile data: (Cannot be checked with the watch. Transfer these data to a personal computer and check them together with the other log data.)
- The profile data are the depths measured every 5 seconds and water temperatures measured every 5 minutes in the diving mode.
- If the log data contains the profile data, the dot indicator indicates "PLOG". The profile data of up to the latest 6 hours can be stored. If the total diving time exceeds about 6 hours, the stored data are deleted from the oldest one. Accordingly, it is recommended to transfer the profile data to a personal computer before the total diving time exceeds about 6 hours.

LOG MODE

Indication mode when no data is recorded

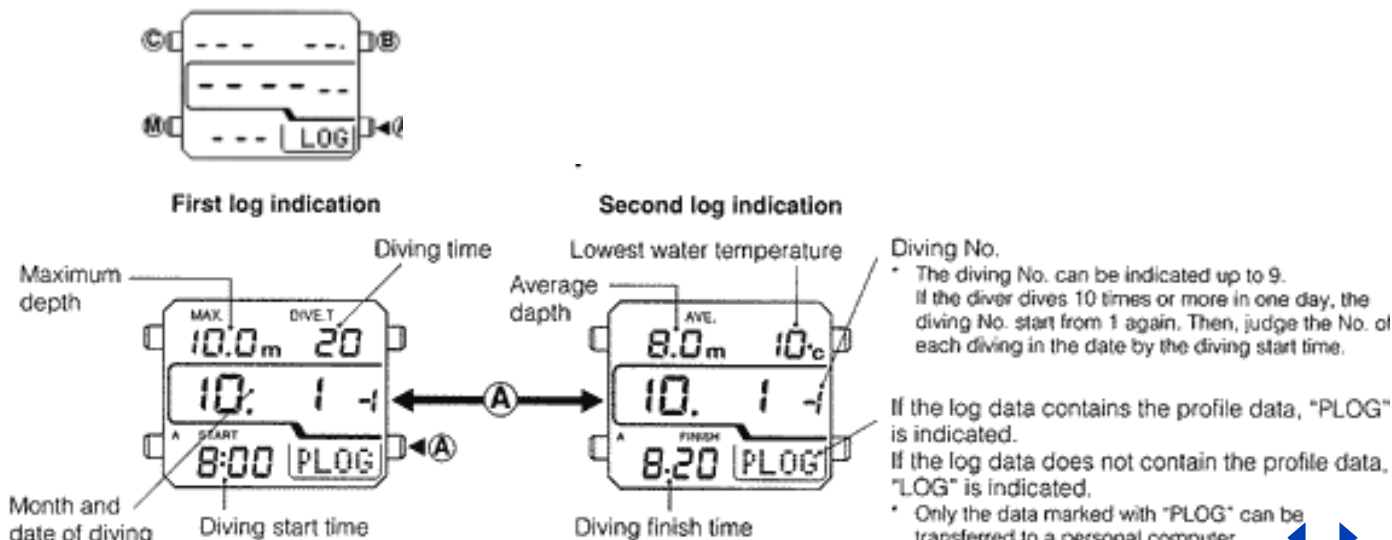



The log data are indicated, divided into the first log data and second log data. Change them over by pushing the **(A) (lower right)** button.

First log data:

Maximum depth, diving time, month and date of diving, diving No., and diving start time

Second log data:

Average depth, lowest water temperature, diving finish time

How to call the log data

- Push the **(B) (Upper right)** button, and the recorded log data are indicated in order from the latest one.
- Push the **(C) (Upper left)** button, and the recorded log data newer than the one currently indicated are indicated in order from the currently indicated one.

How to delete all the log data

- Push the **(B) (Upper right)** button and **(C) (Upper left)** button at the same time and hold for 2 seconds, and an alarm sound comes out and all the log data and profile data are deleted.

11. TRANSFER MODE

In this mode, the diving data can be transferred to a personal computer.

- In this mode, the data in the watch can be transferred to a personal computer by using the communication unit and RS-232 straight cable.
- Applicable personal computer:
IBM PC/AT or compatible (Some models may not be usable).
- Log data to be transferred which contain profile data: Eight data of maximum depth, average depth, diving time, month and date of diving, diving No., diving start time, lowest water temperature, and diving finish time.
- Connection:
*Before connecting the cable, be sure to read the "User's manual for the communication unit AQUALAND GRAPH".
 - (1) Confirm that the power switch of the personal computer is turned off.
 - (2) Connect the personal computer and communication unit by the RS-232C straight cable.
 - (3) Turn on the power switch of the personal computer, and start the AQUALAND GRAPH.
 - (4) Set the watch to the transfer mode, and call the data to be transferred.

(How to call)

If the watch is set to this mode the log data containing the latest profile data is indicated first.

If the watch is changed from the log mode to the transfer mode, however, the log data containing the profile data which has been indicated in the log mode is indicated.

Push the **(B) (Upper right)** button, and the profile data are indicated in order from the latest one. Push the **(C) (Upper left)** button, and the profile data are indicated in order from the oldest one.

Select the profile data to be transferred to the personal computer by operating the push buttons.

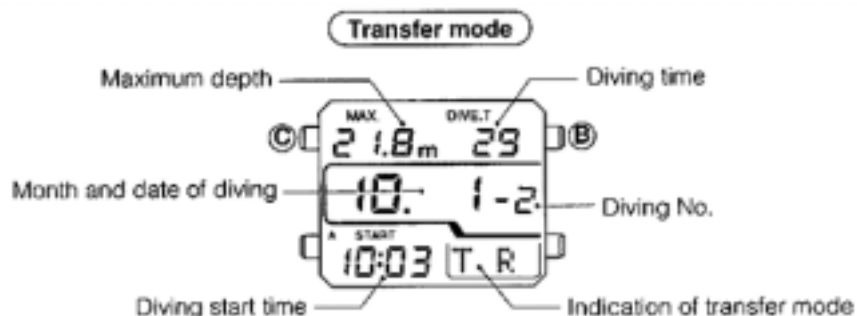

5) Set the watch so that its transfer terminal will be in contact with the central one of the three connection pins (See the figure below).

*Do not touch the three transfer terminals with the bare finger. If they are touched, they may be stained to cause a transfer trouble.

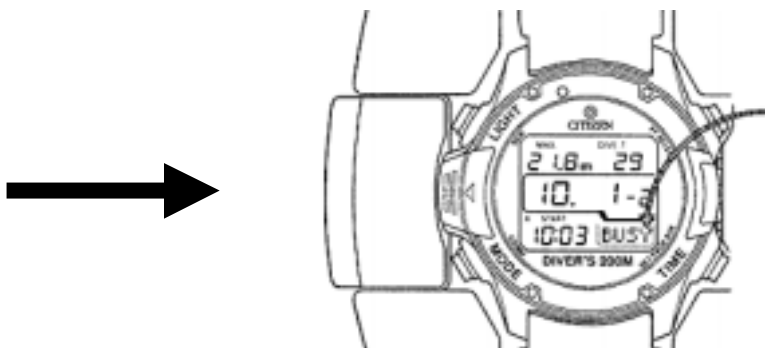
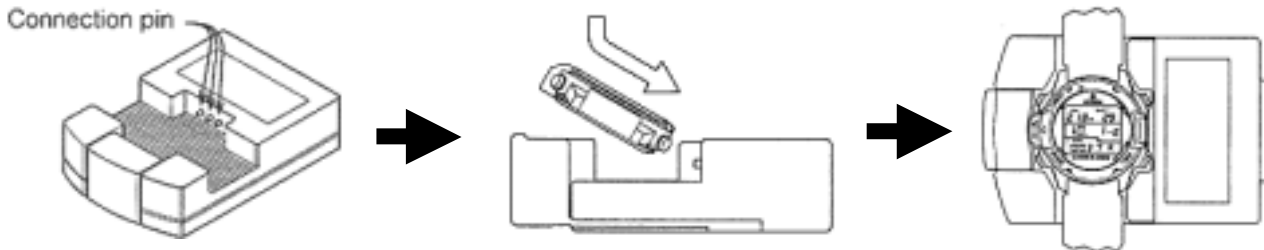

While the data are being transferred, the dot indicator indicates 'BUSY'. If the transfer fails, the dot indicator indicates "ERR". In this case, check PI each connection part, and start the transfer

How to disconnect:

- *Hold the band of the watch, and carefully lift the left side of the watch.
- *Before disconnecting the RS-232C cable, finish AQUALAND GRAPH and turn off the power switch of the personal computer.

12. ALL-RESET PROCEDURE

After the battery is replaced or the watch operates or indicates abnormally, perform the all-reset operation.

- 1) Push and hold the all four push buttons at the same time for 2 seconds, then release them.
 - All the digital segments light up.
- 2) Push any one of the push buttons, then release it.
 - At this time, a confirmation tone sounds to notify the completion of the all-reset operation.
 - * After the confirmation sound, the LED flashes 3 times.
- 3) The watch is set to the time and calendar mode, and it indicates Jan. 01, MON., AM 12: 00.

Precautions for performing the all-reset operation

- Since all the log data and profile data are deleted after the all-reset operation is performed, transfer the data to a personal computer or record them in a log book.
- When releasing the four push buttons at the same time, if the user touches the water sensor, the dot indicator indicates [CHEK]. Then, all the segments light up. After this operation, perform the normal all-reset operation





13. BATTERY LIFETIME FORECAST AND BATTERY

Battery lifetime forecast

- This watch has the battery lifetime forecast to notify the time to replace the battery.
- If the battery comes near the end of its life, "BAT." flashes in the dot indicator window.

PRECAUTION

If the battery lifetime forecast operates in a mode other than the diving mode, the watch cannot be set to the diving mode.

When the battery lifetime forecast operates in the diving mode, if the diving mode is reset, the battery alarm may go off. This phenomenon occurs when the battery is near the end of its life.

Battery

1) Lifetime of battery

Battery life averages 2 years under the following conditions.

- Length of each diving time: 35 minutes
- Number of dives: 100times/year
- Data transfer: Once/week

The lifetime of the battery greatly depends on the frequency of the use of various functions.

If the watch is becomes wet while the user is not diving, the lifetime of the battery is shortened (Since the various functions of the watch for diving start working).

The lifetime of the battery roughly changes as follows, depending on the number of dives (on the assumption that the other conditions are the same as above).

35 min, 200 times/year: 2.2 years

35 min, 300 times/year: 1.8 years



PRECAUTIONS ABOUT CARE AND HANDLING OF WATCHES



TEMPERATURE CARE

Avoid temperature extremes. Exposing your watch to high temperatures, such as placing it on the dashboard of a vehicle or use in a hot tub, may cause the watch to malfunction, shorten battery life or damage certain components. Leaving the watch in extreme cold temperatures may cause irregular timekeeping until the watch returns to normal operating temperature.

SHOCK-RESISTANT

The watch may be worn while playing golf or other activities, but avoid severe shocks such as dropping it on a hard surface.

MAGNETIC-RESISTANT

No problem should occur from using the watch around ordinary household electric appliances such as TV sets or stereos. Keep away from magnets.

CHEMICAL/GAS RESISTANT

Do not expose the watch to chemicals or gases for long periods.

WATCH CLEANING

Stains, waterspots and accumulated dirt on the case, crystal or band should be removed with a soft cloth to prevent damage and premature wear.

HANDLING OF WATER-RESISTANT WATCHES

Although water-resistant watches are warranted, steps should be taken to avoid damage that may result from accidents or mishandling:

- Do not operate the crown or push-button in the water or while the watch is wet. Tighten screw lock crown completely.
- Should the watch become immersed in water, dry it off right away. If the watch comes in contact with salt water, be sure to rinse it thoroughly in warm fresh water to remove any trace of salt.
- If a watch is wet from cleaning or by accident, never store it in a closed container. It should be dried immediately or taken to a watchmaker or jeweler if moisture is inside the case to prevent damage from rust.
- Vital components necessary to resist the entrance of moisture deteriorate with time and use. Gaskets, crowns and other materials should be replaced every year or two to ensure

that water resistant quality remains at factory specifications.

CARE FOR METAL BRACELETS

To extend the life and maintain the good appearance of the metal watch bracelet, the following recommendations are given:

- Be aware that since the watch and bracelet is worn next to the skin, it collects dust and perspiration and becomes soiled if not cleaned regularly. This is particularly true of the inner parts of the links or mesh of the bracelet.
- Soil and rust, when present in a bracelet, are dissolved by perspiration and can cause staining of cuffs and irritation of the skin in some instances.
- Heavy perspiration should be wiped off the watch and bracelet with a soft dry cloth. The bracelet should be cleaned occasionally by using an old toothbrush and warm soapy water after which the soap is thoroughly rinsed with clear water and the bracelet dried completely. The foregoing manner of cleaning should not be done if the watch is not water-resistant but should instead be done by your jeweler.





CARE FOR STRAPS

LEATHER

- Heavy perspiration, if not removed from a leather strap, can wash out the natural oils and cause the leather to become dry and deteriorate. Any moisture should be blotted with a soft dry cloth or paper towel and the strap allowed to dry naturally.
- Salt residue and soil can be removed from the leather by cleaning with a dampened soft cloth and mild soap or saddle soap.
- Occasionally, the inside surface of the strap should be cleaned by using a soft cloth dampened with alcohol.
- The strap should always be worn a little loosely (one finger space between wrist and strap) to allow air to circulate thus causing any moisture to evaporate.

RUBBER

- Rubber straps should be washed frequently with mild soap and warm water using a soft brush.
- Thorough cleaning, using the same method, should especially be done after use in salt water.
- Solvents, oils, perspiration, tanning lotion and salt can cause rubber to deteriorate if not removed.

Marking on the Dial	Marking on the Caseback	 Face washing, splashes, sweat, raindrops, etc.	 Swimming	 Skin diving (diving without air tanks)	 Scuba diving (diving with air tanks)	Water-resistant characteristics
NONE	NONE	NO	NO	NO	NO	Non water-resistant watch and must be kept away from water.
NONE	WATER RESIST	OK	NO	NO	NO	An ordinary water-resistant watch and can withstand splashes, sweat, rain-drops and etc. for daily life use.
WR100M WR10bar WR150M	WATER RESIST	OK	OK	OK	NO	For frequent use with water. It is not specially designed for scuba diving.
WR200M	WATER RESIST	OK	OK	OK	OK	For skin and scuba diving. Usable up to the respective indicated depths.

See instruction book for further information

The water-resistant quality of our timepieces is offered in varying degrees depending on the model. This ranges from non-water resistant models to those suitable for SCUBA diving. Water resistance of our timepieces is measured in BAR or Barometric Pressure. Each BAR of pressure is equal to 14.5 pounds per square inch of pressure.

Water resistance is measured when the watch is at a static, or motionless state. As the watch is moved in water, such as from the motion of swimming, pressure is added from velocity. While you may be swimming in a pool at surface level, the watch may be experiencing forces equal to that of 100 feet of water pressure (3 BAR). Diving into a pool can cause forces on the watch to exceed those pressures. As such, you should always allow a margin of safety when exposing your watch to moisture. Never "push the limit" of the degree of water resistance of your timepiece.

A primary factor to keep in mind about water resistance is that periodic maintenance is needed to maintain original factory specifications for water resistance. When a watch is new, it meets specifications for water resistance as indicated on the case back. However, as the watch ages, the gaskets that seal the watch become dry and brittle, diminishing its water resistant quality. Exposure to environments such as chlorinated pools, salt water or soaps from showering can accelerate drying of the gaskets. We recommend that the gaskets be changed at least every 18 to 24 months to maintain the water resistant quality of your timepiece. If the watch is frequently exposed to chlorinated pools, soaps salt water, etc., we recommend that the gaskets be changed on a yearly basis.

From time to time, you may notice condensation that appears then goes away after a short period of time. This is a normal occurrence and happens primarily from sudden temperature changes. When there are sudden temperature changes such as entering a cool building from the hot out of doors, or jumping into pool on a hot day the watch may fog. Conversely, if you go to the cold outdoors from a warm building, fogging may occur. As long as the fogging clears in a short period of time, there is no need for concern.

Be sure the crown is completely pushed in prior to any contact with moisture. If your model is equipped with a screw down crown, be sure it is properly seated against the case. Do not operate the crown or any push button when the watch is wet as this may allow the entrance of moisture. . If at anytime, you notice moisture in your timepiece that does not clear in a short period of time, you should send your timepiece as soon as possible to the nearest Authorized Service Center for inspection.

You can determine the level of water resistance of our watches from the markings on your case-back. Additionally, models that are water resistant to 100 or 200 meters have an indication on the dial as well. The case-backs and dials are normally marked as follows:

The case back has no indication of water resistance

This indicates the watch is a non water-resistant model and is not designed for contact with moisture at all. Caution should be exercised to avoid any contact with moisture, such as when washing your hands or from a rainstorm.

"Water Resist"

This watch is designed to withstand water from accidental splashing, such as from washing your hands or rain. Any submersion into water may result in the entrance of moisture.

"Water Resist 10BAR" or "W.R. 10BAR", Dial marked "WR100"

This watch is designed to withstand water pressure up to 333 feet. This includes water exposure from accidental splashing and rain, but also from showering, swimming in a pool and snorkeling. Be sure to rinse the watch with fresh water after exposure to a chlorinated pool, salt water, soaps, etc. After rinsing with fresh water, be sure to dry the exterior with a soft cloth.

"Water Resist 20BAR" or "W.R. 20BAR", Dial marked "WR200"

This watch is designed to withstand water pressure up to 666 feet. This includes all exposure to water up to and including recreational SCUBA diving. Be sure to rinse the watch with fresh water after exposure to a chlorinated pool, salt water, soaps, etc. After rinsing with fresh water, be sure to dry the exterior with a soft cloth.

Special Note about Jacuzzis and Hot Tubs

The various components used in the manufacture and assembly of your watch expand at various rates. This results in a loss of the sealing capabilities of gaskets, which may allow moisture to enter. In addition, heat from these sources can cause deformation of certain materials leading to mechanical failures. For these reasons, you should remove your watch before entering a hot tub or Jacuzzi.